

<b>SCIWIL</b>	No.:	<b>XSW-J-04-0004-2023</b>			
	Name:	<b>User Manual K60-A</b>			
Issued on:	30 <sup>th</sup> Aug, 2023	<b>Version</b>	<b>A/0</b>	<b>Page 1 of 31</b>	
Written By:	Zhang Pei	Rev.:	Liu Jian	Apprv.:	Luo Zhenrong

# USERS GUIDE

## K60-A







**Changzhou Sciwil E-Mobility Technology Co., Ltd.**

9<sup>th</sup> Huashan Road, Changzhou, Jiangsu, China- 213022

Fax: +86 519-85602675 Tel: +86 519-85600675

# Contents

<b>1. Product Introduction</b> .....	6
1.1 Product Name and Model .....	6
1.2 Specifications .....	6
1.3 Functions .....	6
1.4 Exterior Look and Size .....	7
1.5 Assembly .....	7
1.6 Cable Connection .....	8
1.7 Extended Function .....	9
<b>2. Display Guide</b> .....	9
2.1 Interface Introduction .....	9
2.1.1 Display Interface (Speed Switch) .....	9
2.1.2 Setting Interface .....	10
2.2 Key Pad Operation .....	10
2.2.1 Key Pad Introduction      .....	11
<b>3. General Operations</b> .....	11
3.1 Switch On/Off .....	11
3.2 Assist Level .....	11
3.3 Interface Switching.....	12
3.3.1 Item Switching (Range/Voltage/Riding Time).....	12
3.3.2 Speed Mode Switching (AVG/MAX Speed).....	12
3.4 Front Light On/Off .....	13
3.5 6km/h Walk Assist Mode .....	13

<b>4. Settings</b> .....	14
4.1 System Unit .....	14
4.2 Backlight Brightness .....	15
4.3 Auto-Off .....	15
4.4 Auto-Lamp On/Off .....	15
4.5 Battery Indication .....	16
4.6 Wheel Size .....	16
4.7 Voltage Level .....	17
4.8 Low Battery Level .....	17
4.9 Boot Password .....	17
4.10 Advanced Settings .....	18
4.11 Speed Limit .....	18
4.12 Controller Current Limit .....	19
4.13 Auto-Cruise .....	19
4.14 Assist Levels .....	19
4.15 Torque Level Range .....	20
4.16 Magnet Steel Number for Speed Test .....	20
4.17 Start Mode .....	20
4.18 Drive Mode .....	21
4.19 PAS Sensor Type .....	21
4.20 Start Sensitivity .....	21
4.21 Start Strength .....	22
4.22 Factory Reset .....	22
4.23 Information .....	22

5. <b>Error Code</b> .....	23
5.1 Error Code Definition .....	23
6. <b>Serial Code</b> .....	24
7. <b>Safety Notes</b> .....	25
8. <b>Quality and Warranty</b> .....	26
8.1 Warranty Term .....	26
8.2 Warranty Exclusions .....	26
9. <b>Version</b> .....	26

## 1. Product Introduction

Congratulations on purchasing your e-bike smart display. Before use, please read through this manual. It is important to acknowledge all the **WARNINGS, SAFETY NOTES AND INSTRUCTIONS**. This manual will walk you through assembly, settings and operations of Sciwil display products in easy steps, to facilitate operations on your e-bike.

## 1.1 Product Name and Model

Product Name: E-Bike Display

Product Model: K60-A

## 1.2 Specifications

- ① Working Voltage: DC 24V/36V/48V/60V/72V
- ② Rated Working Current: 12mA
- ③ Leakage current: <1uA
- ④ Screen Size: 3.5" OLED (480\*320 dots)
- ⑤ Communication Type: UART (by default) / CAN
- ⑥ Working Temperature: -20°C ~ 70°C
- ⑦ Storage Temperature: -30°C ~ 80°C
- ⑧ Waterproof Rating: IP65

## 1.3 Functions

1.3.1 Boot password

1.3.2 System unit switch (km/h or mph)

1.3.3 Speed display:

real-time speed (SPEED), max speed (MAX), average speed (AVG)

1.3.4 Assist Level Control

1.3.5 Battery indication: battery capacity, low voltage indication, BMS info display

1.3.6 Front light indication: front light status supported by controller

1.3.7 Distance: single-trip distance (TRIP), total travel distance (ODO)

1.3.8 Riding Time: TIME

1.3.9 Communications port connection, for system maintenance and specs settings

1.3.10 Walk assist mode

1.3.11 Bluetooth communication, support OTA upgrade via mobile phone

1.3.12 Error code indication Simple key pad for easy & clear operation

## 1.4 Exterior Look and Size

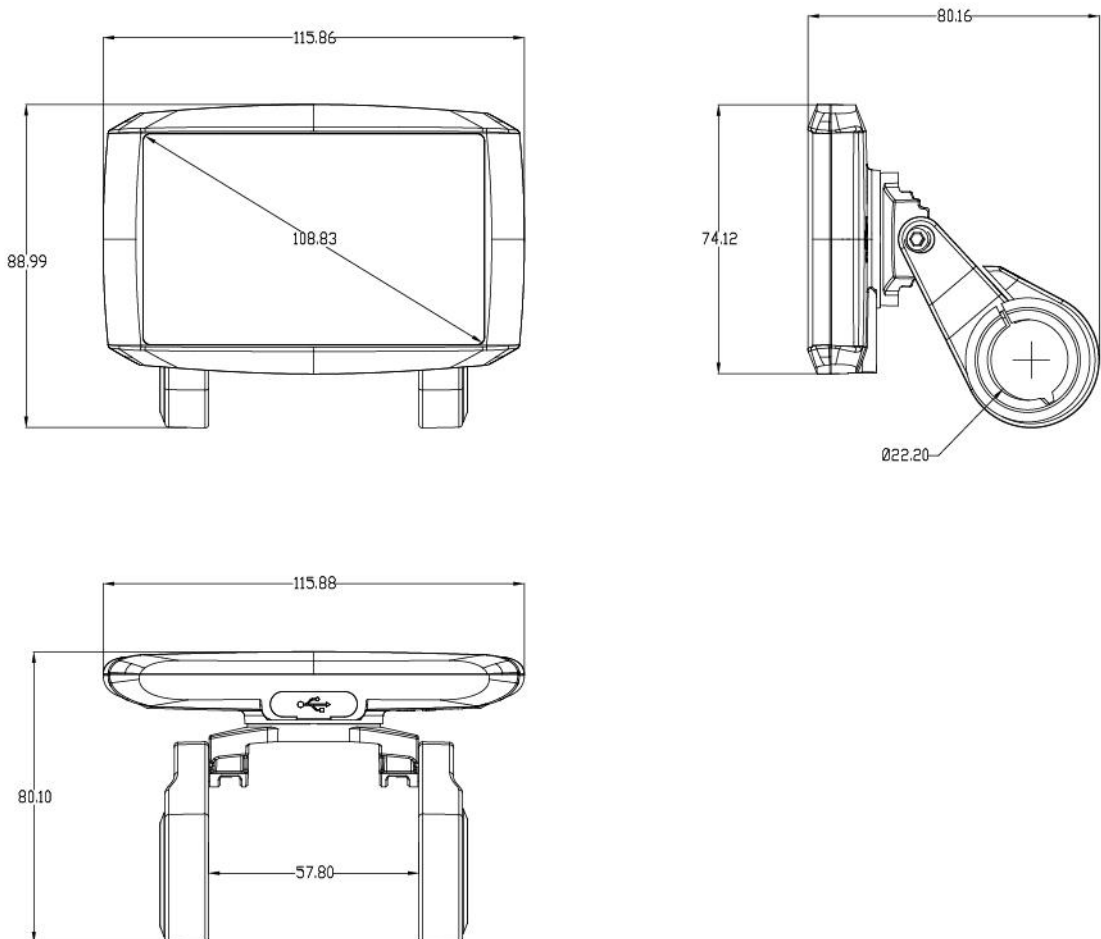

## 1.5 Assembly

1.5.1 Open the holder ring/rubber spacer of the display and fix the display on the handlebar, adjust it to a proper facing angle. Use a M4 Hex Wrench to fix and tighten the screws. Standard fixing torque: **0.8N·m**.

\*Damage due to extra fixing torque is not covered by warranty.

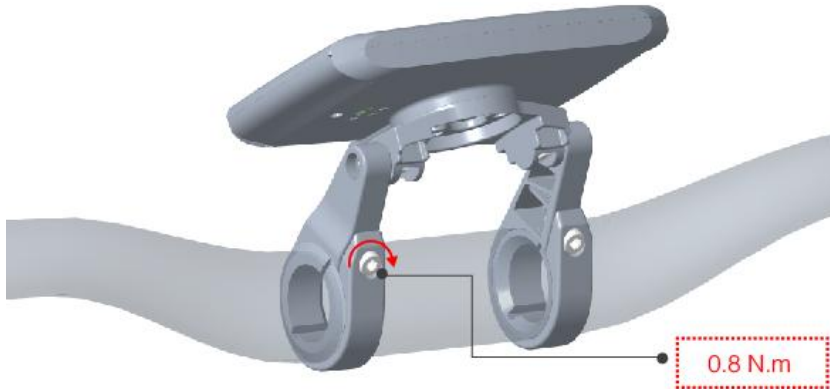

1.5.2 Make sure your e-bike is powered off, then plug the connector on the display to the connector on the controller (bus) to finish standard assembly.

## 1.6 Cable Connection

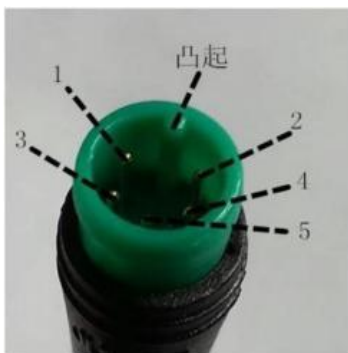

Display to Controller



Controller to Display

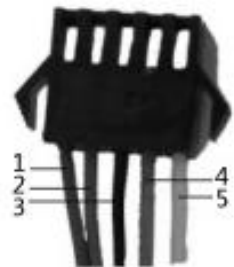

Controller Connector

Sequence No.	Wire Color	Functions
1	Red (VCC)	Display Power Cable
2	Blue (DS)	Controller Power Cable
3	Black (GND)	Display Ground Cable
4	Green (RX)	Display Data Receiving Wire
5	Yellow (TX)	Display Data Sending Wire



## 1.7 Extended Function:

Front Light: Brown Wire (Front Light Power+)

White Wire (Front Light GND)

## 2. Display Guide

### 2.1 Interface Introduction

#### 2.1.1 Display Interface

#### 2.1.2

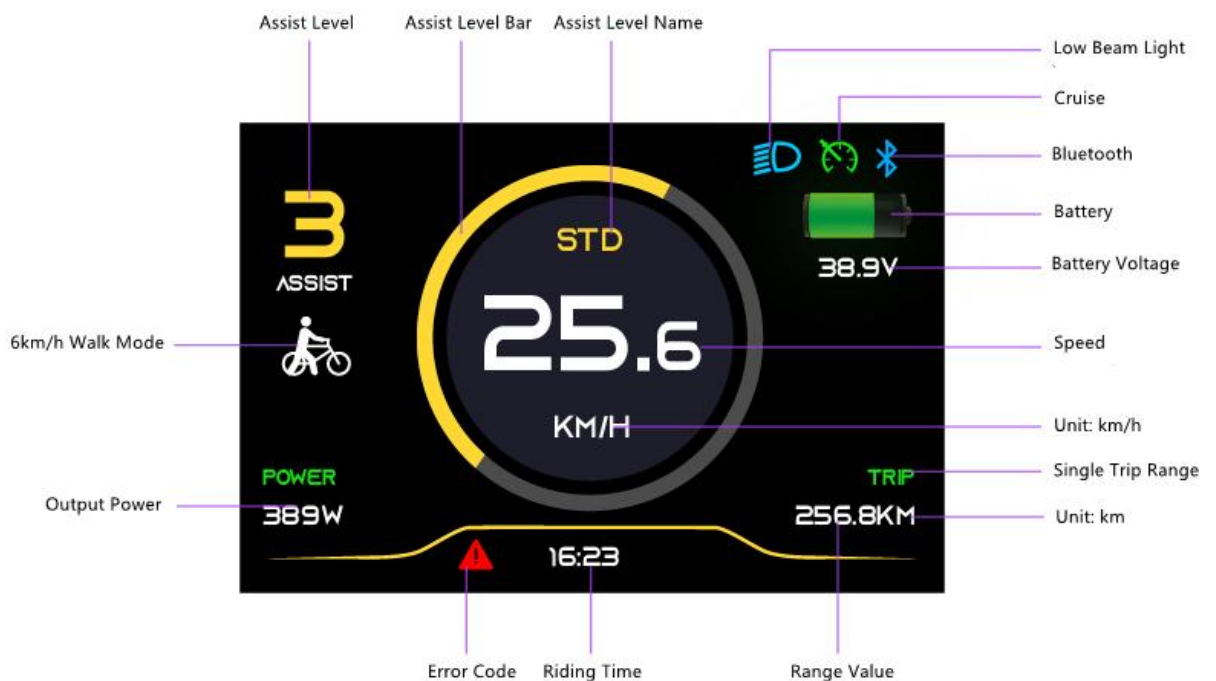

- Real-Time Speed (RT SPEED): current riding speed
- Average Speed (AVG SPEED): average riding speed

- Maximum Speed (MAX SPEED): the max speed during ride
- Total Travel Distance (ODO): total riding distance, max value 99999.9
- Assist Level and Walk Mode: Assist Level 3/5/9 levels, can be changed.
- Current Speed and Unit: current riding speed, unit: km/h or mph
- Single-Trip Distance and Unit: with accuracy of 0.1, max value 99999.9
- Battery Indication: the current battery level
- Front Light Indication: shows icon when the front light is turned on by display
- Power Indication: real-time motor output power





## 2.1.2 Setting Interface

MENU	
Display Settings	Basic Settings
→ System Unit	km/h
Brightness	
Auto-off	OFF
Auto Lamp	OFF

## 2.2 Key Pad Operation





## 2.2.1 Key Pad:

Function Key:  , Plus Key:  , Minus Key  , Light On/Off:  , Info: 

## 3. General Operations



### 3.1 Switch On/Off

Keep the display connected with controller, press and hold Mode  for 2s to turn on the display. The display will show complete interface first before entering into riding interface.

When the display is on, press and hold Mode  for 2s to turn off the display.

The display will automatically turn off if no operation happened within 10min and speed remains 0 (the auto-off time can be set in the Settings).

### 3.2 Assist Level

Press Plus  or Minus  to toggle assist levels. Generally, there are 3/5 levels available. The display shows 1 as default start level, level 0 means no pedal assist output. (the selection interface of assist level see below)

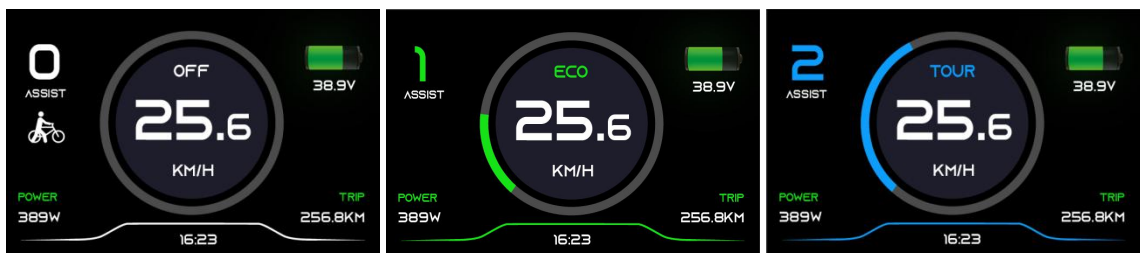

Level0

Level1

Level2

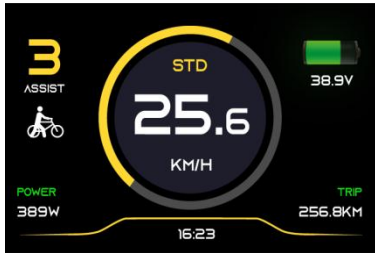

Level3

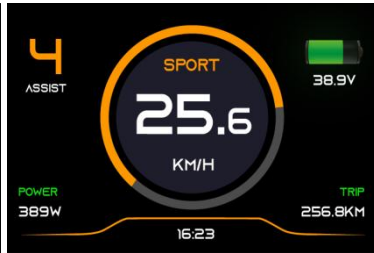

Level4

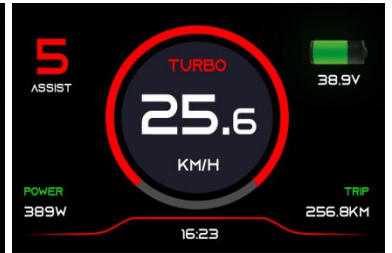

Level5



Walk Assist Mode

### 3.3 Interface Switching

Press Info **i** to toggle display info among total distance (ODO), single-trip distance (TRIP), current voltage, riding time, average speed (AVG), max speed (MAX).

#### 3.3.1 Item Switching (ODO/TRIP/Voltage/Riding Time)

Item switching interface as follows:

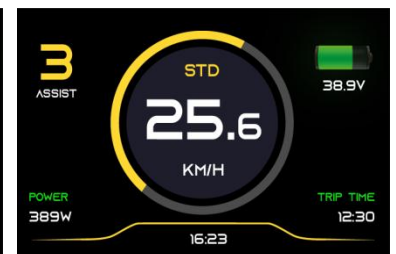
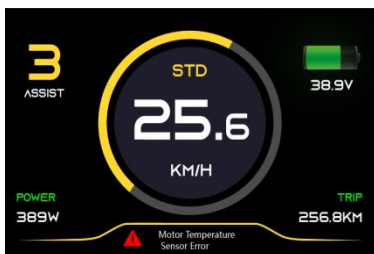
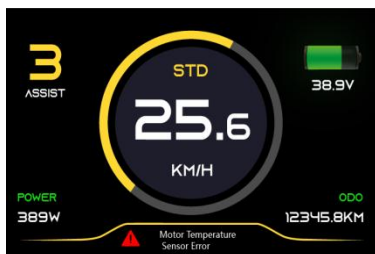



#### 3.3.2 Speed Mode Switching (AVG/MAX)

Speed mode switching Interface as follows:





### 3.4 Front Light On/Off

For display-controlled front light, press Light On/Off  and the front light will be on and the dipped beam icon will be shown in the riding interface. Press Light On/Off  the front light will be off; the dipped beam light icon is also off.



### 3.5 6km/h Walk Assist Mode (Walk Mode)

Press and hold Minus  for 2s to enter 6km/h walk assist mode, the current speed shows in the Assist Level section. Release Minus  to exit walk assist mode. Walk mode switching interface as follow (under walk mode).



**\*This function may not be supported by some controllers.**

## 4. Settings



### Introduction of Setting Operations

1. Press and hold Plus **+** and Minus **-** together for 2s to enter the settings interface. You may set Working Voltage, Wheel Size (inch), Magnetic Steel Number, Speed Limit ect. Please refer to Settings P01-P17 for parameters available.

Under the setting interface, you may press Plus **+** and Minus **-** to increase/decrease the setting value. The value will blink after being modified. Press

Info **i** to switch to the next item and save the previous changes automatically.

2. Press and hold Plus **+** and Minus **-** together for 2s again to save the adjusted value and exit the settings interface. Otherwise system will automatically exit and save values after 10 seconds.

### 4.1 System Unit: km/h or mph

Press Plus or Minus to choose metric (km/h) or imperial (mph) unit.

MENU	
Display Settings	Basic Settings
→ System Unit	km/h
Brightness	
Auto-off	OFF
Auto Lamp	OFF

MENU	
Display Settings	Basic Settings
→ System Unit	mph
Brightness	
Auto-off	OFF
Auto Lamp	OFF

## 4.2 Backlight Brightness

Press Plus or Minus to choose among |~||||. | is darkest, |||| is brightest.

MENU	
Display Settings	Basic Settings
System	km/h
→ Brightness	
Auto-off	OFF
Auto Lamp	OFF

MENU	
Display Settings	Basic Settings
System	km/h
→ Brightness	
Auto-off	OFF
Auto Lamp	OFF

## 4.3 Auto-Off

Press Plus or Minus to select 1~60min as auto-off time, which means the display will turn off automatically if no operations detected within this period of time.

Default Auto-Off time: 10min

MENU	
Display Settings	Basic Settings
System	km/h
Brightness	
→ Auto-off	OFF
Auto Lamp	OFF

MENU	
Display Settings	Basic Settings
System	km/h
Brightness	
→ Auto-off	9min
Auto Lamp	OFF

MENU	
Display Settings	Basic Settings
System	km/h
Brightness	
→ Auto-off	1min
Auto Lamp	OFF

## 4.4 Auto-Lamp On/Off

Press and hold  to turn on or off the front light automatically.

MENU	
Display Settings	Basic Settings
System	Metric
Brightness	
Auto-off	OFF
→ Auto Lamp	OFF

MENU	
Display Settings	Basic Settings
System	Metric
Brightness	
Auto-off	OFF
→ Auto Lamp	ON

Digital scenario or analog scenario switch. \* The current version only supports digital scenario

## 4.5 Battery Indication

Press Plus or Minus to select among Voltage/Percentage/Off. Battery indicator on the display will toggle among voltage value, battery percentage left and none.

\* Battery percentage display requires system-BMS communications.

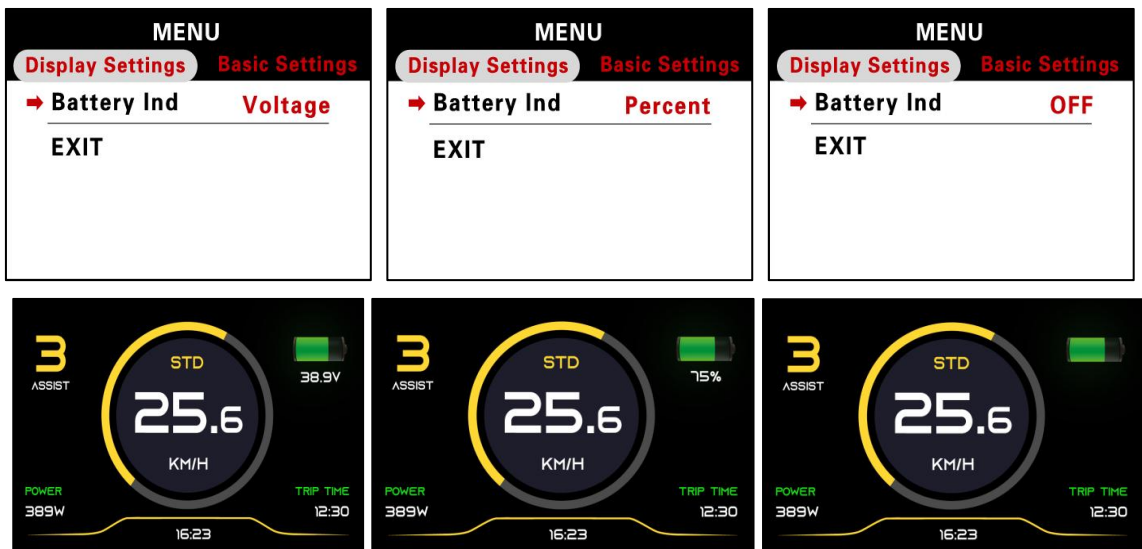

## 4.6 Wheel Size

Press Plus or Minus to set the correct wheel size. Default wheel size: 26inch. Incorrect or inaccurate wheel size may lead to incorrect speed display.

Unit: inch, increment 0.1inch.



MENU	
Display Settings	Basic Settings
→ Wheel	12inch
Battery	36V
Low Battery	>
Password settings	>

MENU	
Display Settings	Basic Settings
→ Wheel	31inch
Battery	36V
Low Battery	>
Password settings	>

MENU	
Display Settings	Basic Settings
→ Advance settings	>
Factory settings	>
Information	
EXIT	

## 4.7 Voltage Level

Press Plus or Minus to select. Working voltage range: 24~72V.

MENU	
Display Settings	Basic Settings
Wheel	12inch
→ Battery	24V
Low Battery	>
Password settings	>

MENU	
Display Settings	Basic Settings
Wheel	12inch
→ Battery	36V
Low Battery	>
Password settings	>

MENU	
Display Settings	Basic Settings
Wheel	12inch
→ Battery	48V
Low Battery	>
Password settings	>

## 4.8 Low Battery Level

In light of low battery protection volt level, press Plus or Minus to set low-battery protection level for the vehicle.

MENU	
Display Settings	Basic Settings
Wheel	12inch
Battery	36V
→ Low Battery	30.0V
Password settings	>

MENU	
Display Settings	Basic Settings
Wheel	12inch
Battery	36V
→ Low Battery	23.4V
Password settings	>



MENU	
Display Settings	Basic Settings
Wheel	12inch
Battery	36V
→ Low Battery	0.1V
Password settings	>

## 4.9 Boot Password

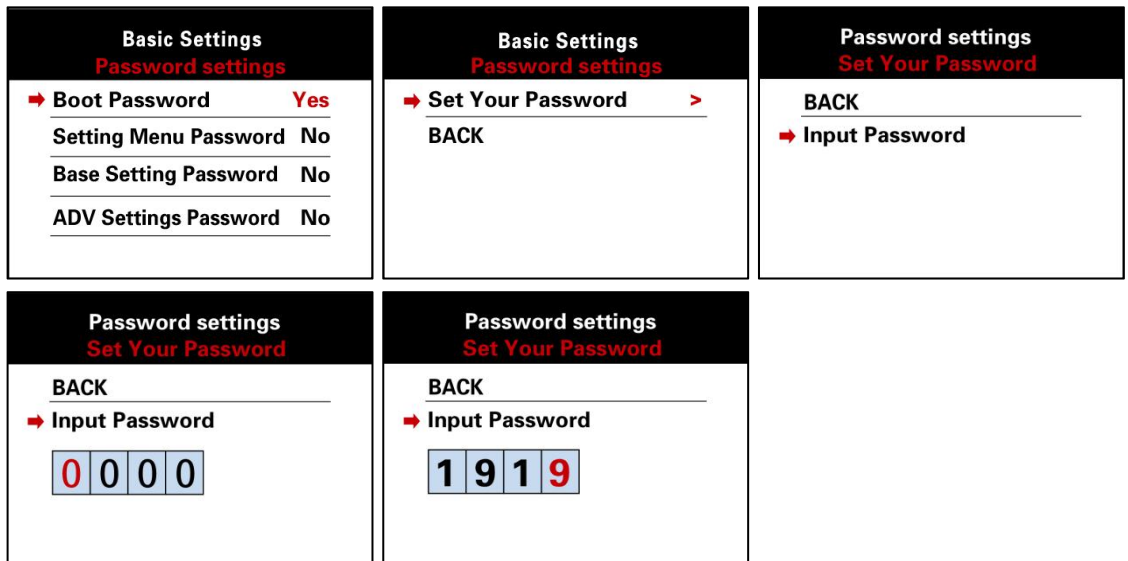
Press **M** to enter Password Settings. First to set is 4-digit boot password (as shown in the pictures below). Then you can set in turn passwords for setting menu, basic settings, advanced settings and change password.



## 4.10 Advanced Settings

Press  to enter Advanced Settings. For password protected product, enter the correct password and press  to enter Advanced Setting. Press Plus or Minus to set values, then press  to save and switch to the next item.

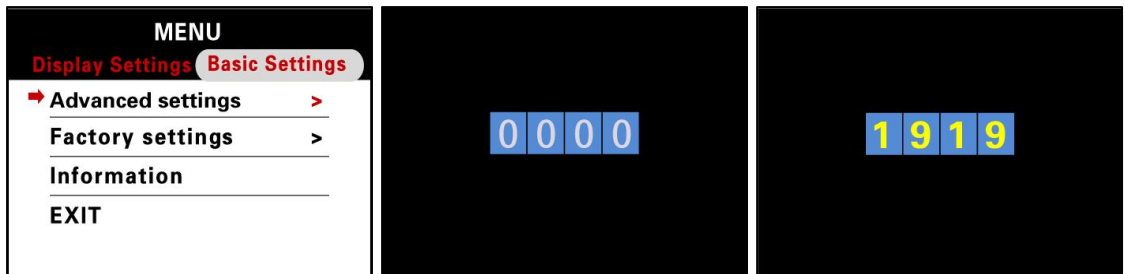

## 4.11 Speed Limit

Press Plus or Minus to set values for speed limit. Min. Value: 10km/h, Max. Value: 100km/h, increment: 1km/h. Default speed limit: 100km/h.

Basic Settings		Basic Settings		Basic Settings	
Advanced Settings		Advanced Settings		Advanced Settings	
→Speed limit	10km/h	→Speed limit	25km/h	→Speed limit	45km/h
Current limit	15A	Current limit	15A	Current limit	15A
Auto Cruise	No	Auto Cruise	No	Auto Cruise	No
Assist levels	5	Assist levels	5	Assist levels	5

## 4.12 Current Limit

Press Plus or Minus to set values for current limit. Min. Value: 6A,

Max. Value: 50A. Default speed limit: 15A.

Basic Settings		Basic Settings		Basic Settings	
Advanced Settings		Advanced Settings		Advanced Settings	
Speed limit	10km/h	Speed limit	10km/h	Speed limit	25km/h
→Current limit	6A	→Current limit	15A	→Current limit	18A
Auto Cruise	No	Auto Cruise	No	Auto Cruise	No
Assist levels	5	Assist levels	5	Assist levels	5

## 4.13 Auto-Cruise

Press Plus or Minus to turn on or off the auto-cruise function.

Basic Settings		Basic Settings	
Advanced Settings		Advanced Settings	
Speed limit	10km/h	Speed limit	25km/h
Current limit	15A	Current limit	18A
→Auto Cruise	No	→Auto Cruise	Yes
Assist levels	5	Assist levels	5

## 4.14 Assist Levels

Press Plus or Minus to select assist level mode: 3 levels / 5 levels.

Basic Settings		Basic Settings	
Advanced Settings		Advanced Settings	
Speed limit	10km/h	Speed limit	10km/h
Current limit	15A	Current limit	15A
Auto Cruise	No	Auto Cruise	No
→ Assist levels	3	→ Assist levels	5

## 4.15 Torque Level Range

Press Plus or Minus to select signal voltage level for torque sensor:

500mV / 3500mV.

Basic Settings		Basic Settings		Basic Settings	
Advanced Settings		Advanced Settings		Advanced Settings	
→Torque level range	500mV	→Torque level range	1000mV	→Torque level range	3500mV
Poles in motor	46	Poles in motor	46	Poles in motor	46
Start mode	Zero	Start mode	Zero	Start mode	Zero
Drive mode	2	Drive mode	2	Drive mode	2

## 4.16 Poles in Motor

Press Plus or Minus to set number of magnetic poles for speed gauge.

Min. Value: 1, Max. Value: 255. Default poles number: 1.

Basic Settings		Basic Settings		Basic Settings	
Advanced Settings		Advanced Settings		Advanced Settings	
Torque level range	500mV	Torque level range	500mV	Torque level range	500mV
→Poles in motor	46	→Poles in motor	50	→Poles in motor	69
Start mode	Zero	Start mode	Zero	Start mode	Zero
Drive mode	2	Drive mode	2	Drive mode	2

## 4.17 Start Mode

Press Plus or Minus to select start mode : Throttle on demand and Throttle after pedal. "Zero" means Throttle on demand, "Non-Zero" means Throttle after pedal.

Basic Settings Advanced Settings	
Torque level range	500mV
Poles in motor	46
→ Start mode	Zero
Drive mode	2

Basic Settings Advanced Settings	
Torque level range	500mV
Poles in motor	46
→ Start mode	Non Zero
Drive mode	2

## 4.18 Drive Mode

Press Plus or Minus to select drive mode: 0 / 1 / 2. 0 means pedal assist only, 1 means throttle only, 2 means both modes available.

Basic Settings Advanced Settings	
Torque level range	500mV
Poles in motor	46
Start mode	Zero
→ Drive mode	0

Basic Settings Advanced Settings	
Torque level range	500mV
Poles in motor	46
Start mode	Non Zero
→ Drive mode	1

Basic Settings Advanced Settings	
Torque level range	500mV
Poles in motor	46
Start mode	Non Zero
→ Drive mode	2

## 4.19 PAS Sensor Type

Press Plus or Minus to select PAS Sensor Type: 5 / 8 / 12. This value is the number of magnetic steels on the PAS disc.

Basic Settings Advanced Settings	
→ PAS Disc	5
Start Sensitivity	2
Start Strength	3
EXIT	

Basic Settings Advanced Settings	
→ PAS Disc	8
Start Sensitivity	2
Start Strength	3
EXIT	

Basic Settings Advanced Settings	
→ PAS Disc	12
Start Sensitivity	2
Start Strength	3
EXIT	

## 4.20 Start Sensitivity

Press Plus or Minus to select start sensitivity range: 1~24. This value is the start latency after pedal.

Basic Settings Advanced Settings		Basic Settings Advanced Settings		Basic Settings Advanced Settings	
PAS Disc	5	PAS Disc	5	PAS Disc	5
→ Start Sensitivity	0	→ Start Sensitivity	1	→ Start Sensitivity	2
Start Strength	3	Start Strength	3	Start Strength	3
EXIT		EXIT		EXIT	

## 4.21 Start Strength

Press Plus or Minus to select start sensitivity range: 0~5. This value is the start power output after pedal.

Basic Settings Advanced Settings		Basic Settings Advanced Settings		Basic Settings Advanced Settings	
PAS Disc	5	PAS Disc	5	PAS Disc	5
Start Sensitivity	0	Start Sensitivity	0	Start Sensitivity	0
→ Start Strength	0	→ Start Strength	1	→ Start Strength	5
EXIT		EXIT		EXIT	

## 4.22 Factory Reset

Press  to enter the Factory Reset Interface. Select YES to reset to factory setting, Select Exit to return to the previous menu.

MENU		Basic Settings Factory settings		Basic Settings Factory settings	
Display Settings	Basic Settings	YES		YES	
Advanced settings	>	→ ODO	67.5 km	ODO	67.5 km
→ Factory settings	>	BACK		→ BACK	
Information					
EXIT					

## 4.23 Information

Press  to enter the information interface and check info like speed record, distance record and serial numbers, etc.

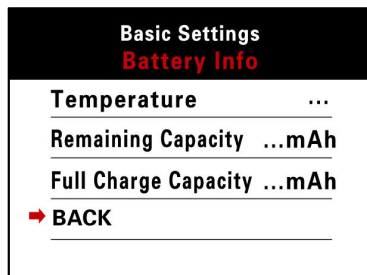
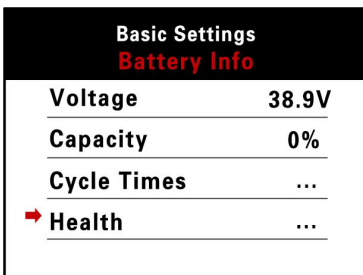
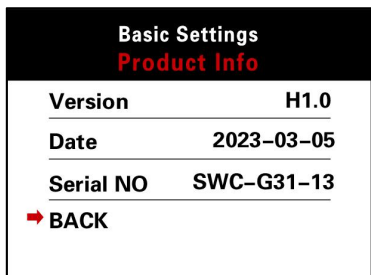
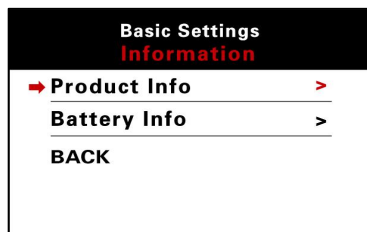
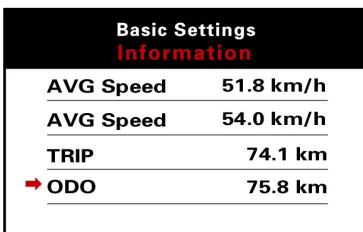
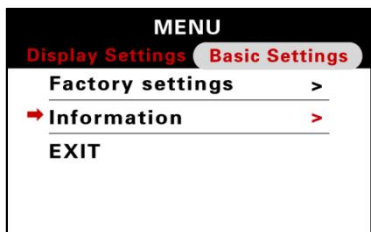

## 5. Error Code

The display can report error codes of the electric vehicle. Error codes will be shown when the display detects corresponding error/failure. The interface is as follows:

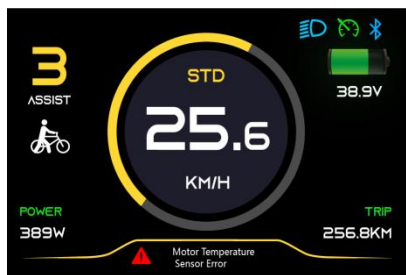

**Error Code Table**

Error Code (decimal)	Status	Note
E00	Normal	
E03	Brake Engaged	
E05	Throttle Failure	
E06	Low Voltage Protection	
E07	Over Voltage Protection	
E08	Motor Hall Signal Error	

E09	Motor Phase Error	
E16	Controller Error	
E23	Front Light Error	
E27	Controller Over Current Error	
E30	Communications Error	

## 6. Serial Code

Each Sciwil display product bears a unique Serial Code on the back shell



(as shown in the photo below): 192 2 1 210603011

Explanation to the above Serial Code:

**192:** Customer Code

**2:** Protocol Code

**1:** Program can be overridden (0 means can not be overridden)

**210603011:** P.O. (purchase order number)



## 7. Safety Notes

PLEASE TAKE CAUTION WHEN USE, DO NOT PLUG OR UNPLUG THE DISPLAY WHILE YOUR E-BIKE IS POWERED ON.



AVOID CLASHES OR BUMPS TO THE DISPLAY.



AVOID USING IN HEAVY RAINS, SNOWS OR LONG EXPOSURE TO STRONG SUNLIGHT. DO NOT TEAR THE WATER-PROOF FILM ON THE SURFACE OF THE SCREEN, OTHERWISE THE WATER-TIGHT PERFORMANCE OF THE PRODUCT MAY BE DEGRADED.



DO NOT PLUG OR UNPLUG THE DISPLAY WHILE THE SYSTEM IS POWERED ON. UNAUTHORIZED ADJUSTMENT TO DEFAULT SETTINGS IS NOT SUGGESTED, OTHERWISE NORMAL USE OF YOUR E-BIKE CAN NOT BE GUARANTEED.



WHEN THE DISPLAY PRODUCT DOES NOT WORK PROPERLY, PLEASE SEND THE IT FOR AUTHORIZED REPAIR IN TIME.

## 8. Quality and Warranty

### 8.1 Warranty Term

In compliance with local laws, Sciwil provides limited warranty period covering 24 months after the date of manufacturing (as indicated by the serial number), applies to quality issues during normal operations.

The limited warranty shall not be transferred to a third party other than as specified in the agreement with Sciwil.

Other situations may be covered, depending on the agreement between Sciwil and the buyer.

### 8.2 Warranty Exclusions:

1. Sciwil products that have been opened, modified or repaired without authorization.
2. Damage on the connectors.
3. Damage to the surface after leaving factory, including shell, screen, buttons, or other appearance parts.
4. Damage to wiring and cables after leaving factory, including breaks and exterior scratch.
5. Damage or loss due to force majeure (e.g. fire or earthquake) or natural disaster (e.g. lightning).
6. Out of the warranty period.

## 9. Version

This display user manual is in compliance with the general software version (A/0) of Changzhou Sciwil E-Mobility Technology Co., Ltd. There are chances that display products on some e-bikes may have a different software version, which should be subject to the actual version in use.